

# alphamesh

SAFETY SYSTEMS

THE FORM-FLEXIBLE  
SHOP LOCKING  
SOLUTION





alphamesh  
SAFETY SYSTEMS

# NIGHT CLOSURE

Universal ring mesh night closure system for areas with direct customer contact. The ring mesh meets the most rigorous safety standards in building protection concepts. The characteristics of the ring mesh also enables the guiding „around the corner“, in one piece and without seams or holders.



## TECHNICAL DESCRIPTION

- **Bottom end profile** consisting of a special U-profile  
Material: steel 37, primed, colour: freely selectable
- **Top end profile** consisting of a special U-profile  
Material: steel 37, primed, colour: freely selectable
- **Ring mesh**  
Material: alphamesh 12.0 stainless steel; open area 63 % (translucent and air-permeable)
- **Upper support structure**, consisting of steel profiles (e.g. RHS 50 x 50 mm)  
Material: Steel 37, primed
- **Drive unit**, consisting of: steel cables with deflection pulleys, drive shaft, drive motor with controller
- **Locking mechanism**: Electromagnets in the floor, or bolt locking mechanism in both lateral guide profiles

## PRODUCT FEATURES

- Protective device from a single and seamless piece of ring mesh.
- It can be realized in virtually any form.
- It can be implemented as a „standalone“ solution, as a ceiling solution, floor solution, or between room elements or partition walls.
- Theoretically implementation is possible in unlimited dimensions.
- Closure system with invisible high-performance electromagnets.
- High degree of customisation depending on customer and application requirements.
- A system without guiding, holder and locking installation or separate components (there are no floor rails, guide rails, corner connections, carrier systems).
- Well thought-out, reduced mechanical basic concept for a long service life with frequent use cycles.
- High-quality and individual components for a trouble-free operation.



# QUALITY WITH DISTINCTION

2021, our security system was awarded the **R+T Innovation Prize** twice. **Silver** in the gates category and **gold** in the design category, which was awarded for the first time.

Furthermore, the system offers security at the highest level.

alphamesh safety systems has been tested by the **independent testing institute in Velbert (PIV)** in accordance with the legal requirements according to **DIN/TS 18194:2020-07** and meets the requirements of **resistance class RC 2**.



# FUNCTIONAL DESCRIPTION

The bottom end profile (U-ground profile), the ring mesh and the top end profile (U-ceiling profile) generate the visible unit of „night closure with alphamesh ring mesh“.

The top end profile with the upper support structure is permanently connected to the ceiling (screened or directly integrated in a suspended ceiling). The top end profile is used to attach and hold the alphamesh ring mesh. If the night closure is completely closed, the top end profile works as a height-regulating element for the closing counterpart: the bottom end profile. The bottom end profile is used as the lower collecting tray of the ring mesh, and is directly connected to the drive shaft by using steel cables and deflection pulleys. With the support of steel cables, pulleys and the drive shaft the bottom end profile will be directly lifted and lowered.

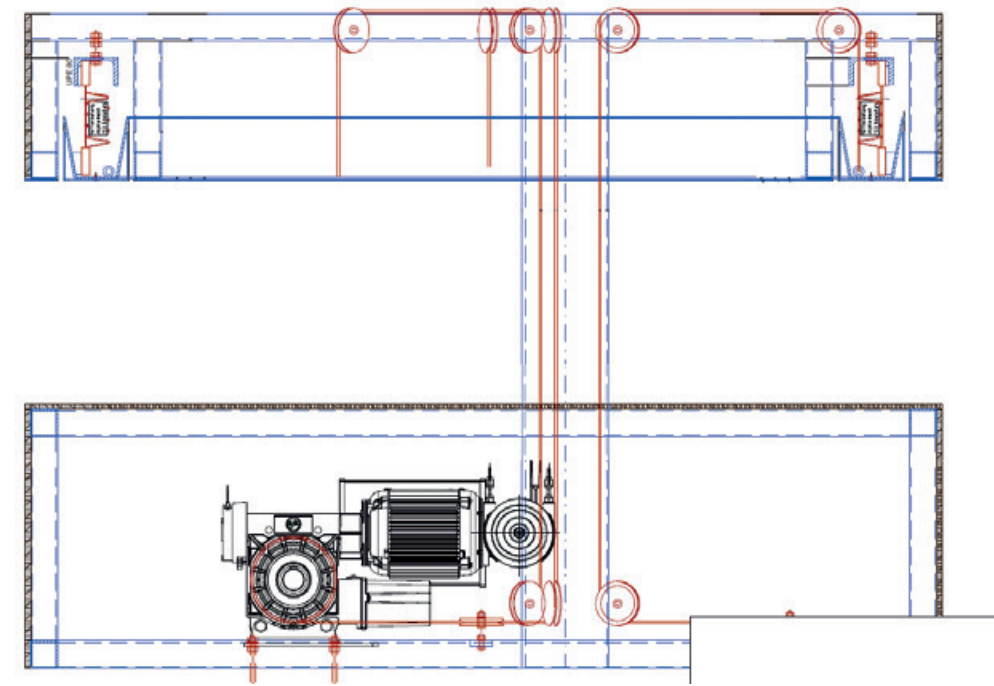

## ELECTROMAGNETIC CLOSURE SYSTEM

The night closure is locked either with electromagnets that are recessed directly and completely in the floor under the ground tray, or with side-mounted locking bolts which are installed at the lower end of the lateral guide profiles.

## DRIVE UNIT

The drive motor (shaft-mounted motor 3 x 400 V) is directly connected to the drive shaft on top. The dimensions and the power of the motor unit depend on the size of the alphamesh safety system. The motor unit can be programmed via a controller, so that the ring mesh night closure can be individually lifted and lowered.

The operation is executed via pushbutton switch, key switch, badge reader or radio remote control with hand-held transmitter. Necessary safety components such as a contact strip (safety edge), light barrier (photocells), etc. can be offered on demand.

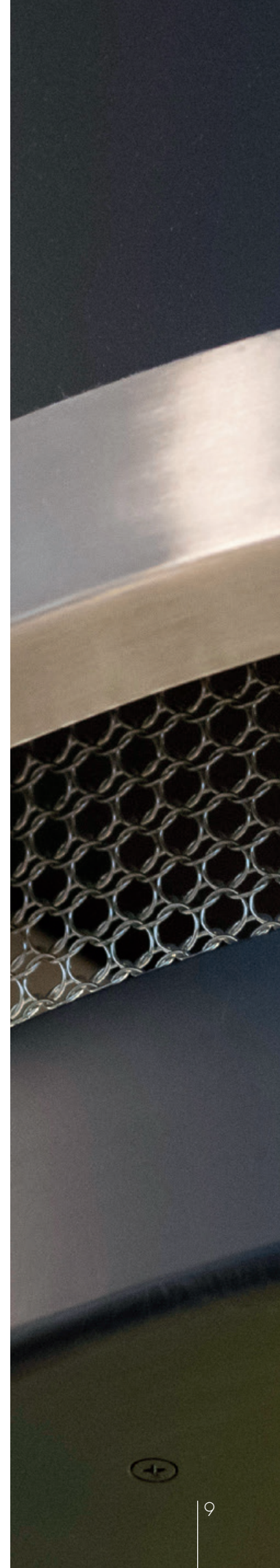



# ATTACHMENT AND INSTALLATION SOLUTIONS

STANDALONE SOLUTION

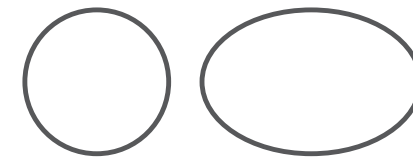

ROUND SHAPES

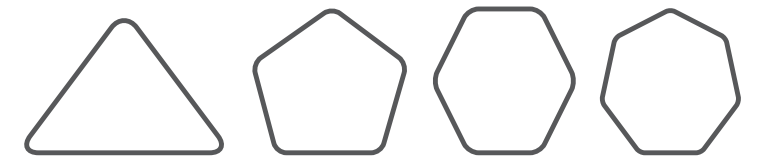

ANGULAR SHAPES



DIAGONAL SOLUTIONS

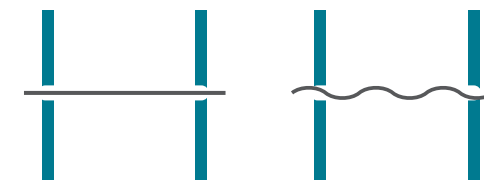

INSTALLATION SOLUTION – LINEAR SHAPES

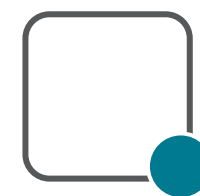

INTEGRATION OF EXISTING CONSTRUCTION ELEMENTS

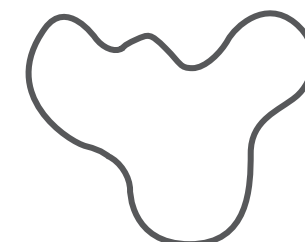

MINIMUM BENDING RADIUS 250 MM

SPECIAL SOLUTION – STANDALONE – AMORPHOUS SHAPES

WIDE RANGE OF APPLICATIONS AND FLEXIBLE, ARCHITECTURAL DESIGN OPTIONS

# PRODUCT FEATURES

## RING MESH

- High-strength material due to laser-welded rings.
- Uniform material quality with almost unlimited dimensions.
- Has already been used successfully as a protection application in demanding architectural projects.
- Used in building protection concepts for explosion and splinter protection.
- Highly polished surface provides an excellent platform for illuminations or light projections.
- Wires made of high-alloy, corrosion-resistant stainless steel AISI 316L.
- Goods which should be protected remain effectively visible behind the transparent ring mesh safety curtain.
- The highly-flexible metal fabric enables a presentation of any geometric shape in one piece.

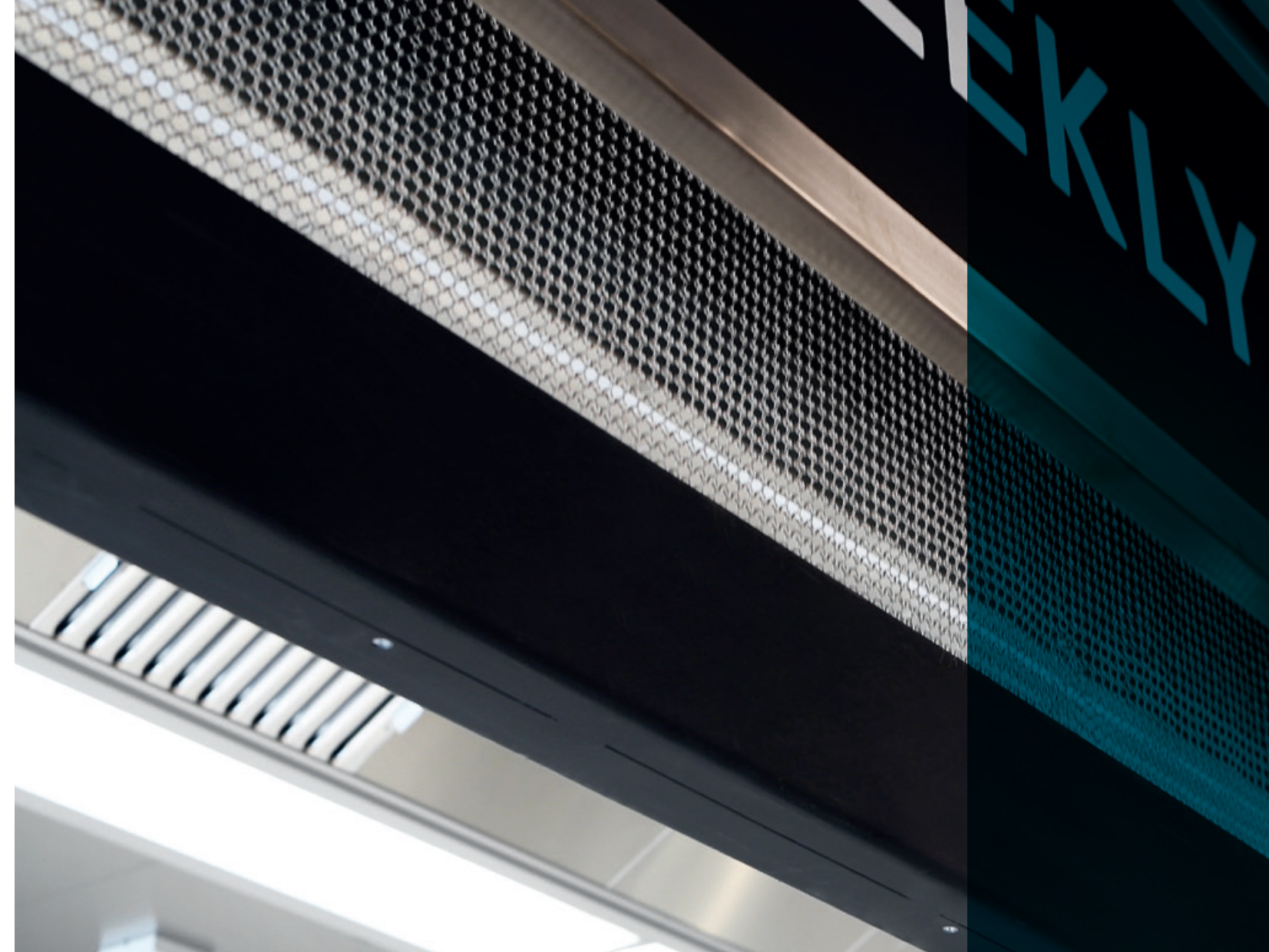
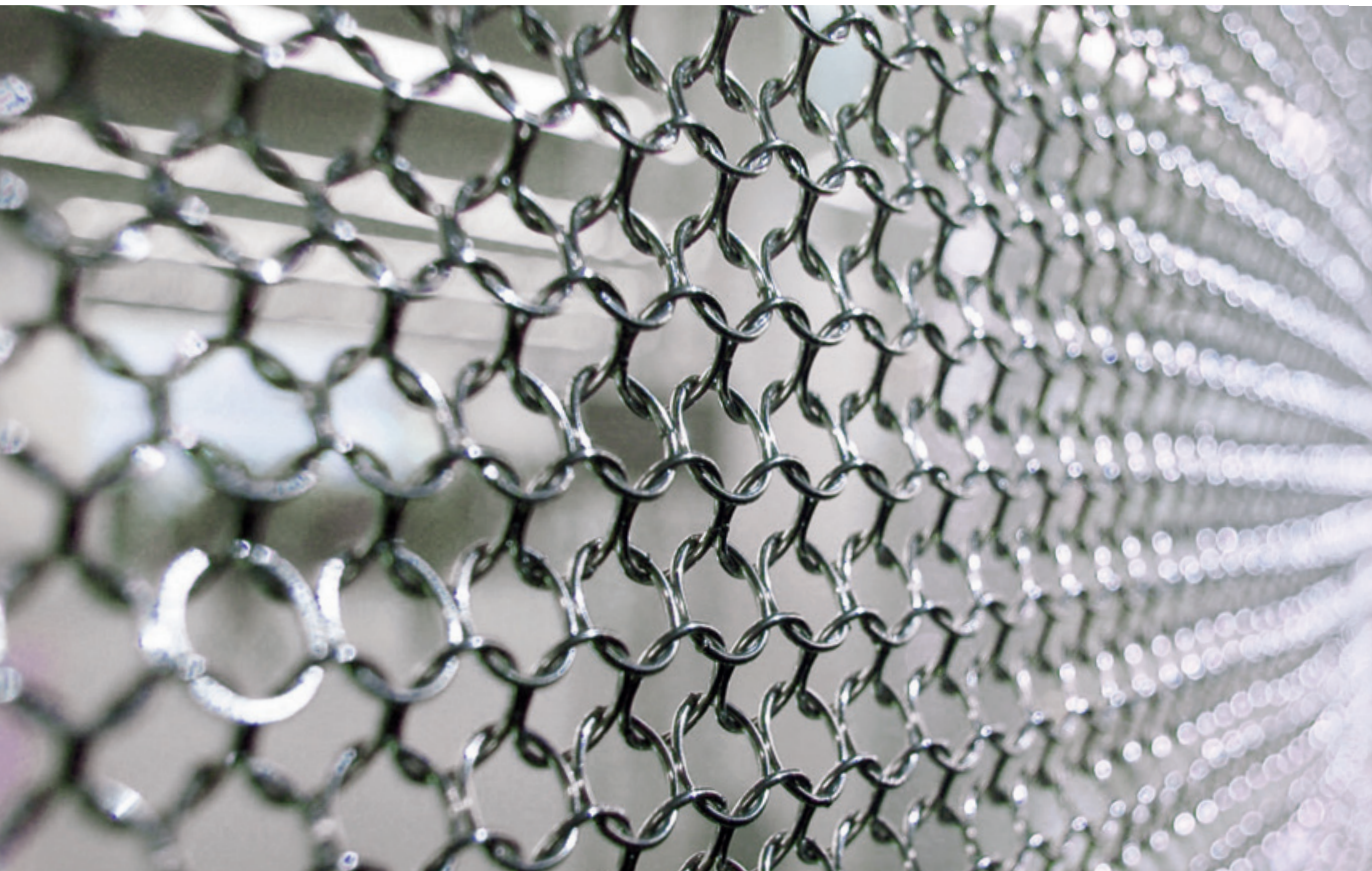

## PRODUCT IN A CLASS OF ITS OWN

Thousands of individual rings are interlinked in alphamesh ring meshes to create a metal fabric with an excellent stability and an unique impression.

The alphamesh manufacturing process ensures to produce the ring mesh in unlimited dimensions. Moreover, the company's high vertical integration allows the development and production of custommade ring mesh solutions.

Stainless steel ring mesh is also one of the top materials in terms of eco-friendliness. It has a long service life, is corrosion-resistant and recyclable.



ONE SYSTEM –  
INDIVIDUAL  
POSSIBILITIES

**alphamesh**  
SAFETY SYSTEMS





**alphamesh**  
SAFETY SYSTEMS

proMesh GmbH  
In den Waldäckern 12/1  
75417 Mühlacker - Germany  
Tel: +49 7041 9544-60  
Fax: +49 7041 9544-55  
info@alphamesh.de  
[www.alphamesh-safetysystems.de](http://www.alphamesh-safetysystems.de)